

ACB64 – PT

Specification Sheet

The ACB64 - PT is an acrylic vacuum chamber, designed specifically as a package testing chamber for use with the water submersion bubble leak testing method for determination of leaks in flexible packaging.

Our ACB chambers are compliant with ASTM D3078-02 and ISO 20484 testing standards, they are pressure tested to 1×10^{-2} mbar and helium leak tested.

They can be supplied as chamber only, or full kits including vacuum pump.

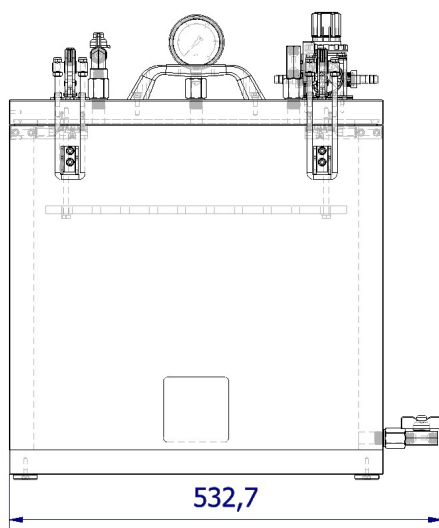
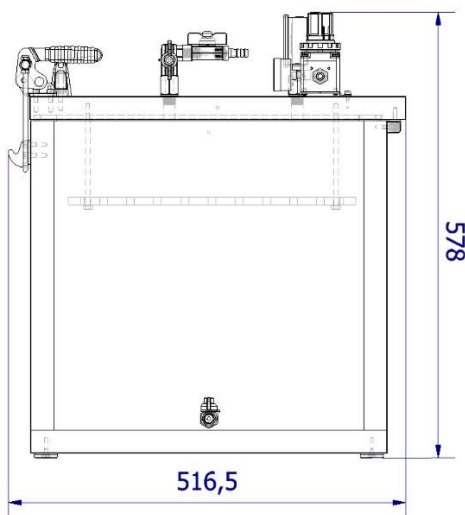
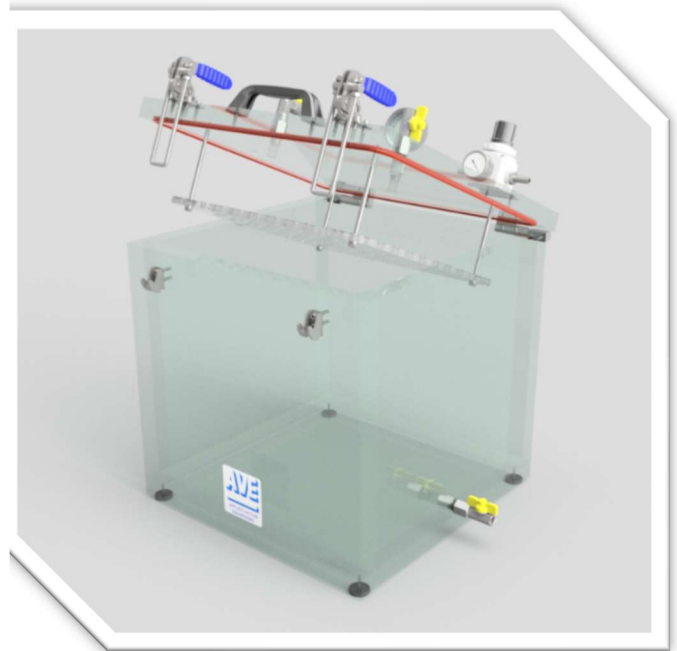

Specifications

- Inside dimensions -
 - 400mm wide x 400mm deep x 400mm high
- Capacity - 64 Litres
- Weight - 48kg Approx.
- Material - Acrylic
- Silicone 'O' ring
- Clear perforated acrylic submerge plate, suspended with stainless steel threaded studs for easy height adjustment
- ¼" BSP drain valve
- Lid mounted 63mm glycerine filled vacuum dial gauge.
- Lid mounted air admittance ball valve
- Lid mounted vacuum inlet port with vacuum isolation ball valve.
- Lid mounted adjustable vacuum regulator, 240 ltr/min maximum flow.
- Over-centre latches to ensure lid seal

Options/Extras

- Vacuum Pump